



■ Features :

- Universal AC input / Full range (up to 305VAC)
- Built-in active PFC function
- High efficiency up to 90%
- Protections: Short circuit / Over current / Over voltage / Over temperature
- Cooling by free air convection
- Fully isolated plastic case
- Fully encapsulated with IP67 level (Note.6)
- Class II power unit, no FG
- Class 2 power unit
- Suitable for LED lighting and moving sign applications
- Compliance to worldwide safety regulations for lighting
- Suitable for dry / damp / wet locations
- 5 years warranty



SPECIFICATION

MODEL		LPF-40-24
OUTPUT	DC VOLTAGE	24V
	CONSTANT CURRENT REGION <small>Note.4</small>	14.4 ~ 24V
	RATED CURRENT	1.67A
	RATED POWER	40.08W
	RIPPLE & NOISE (max.) <small>Note.2</small>	150mVp-p
	VOLTAGE TOLERANCE <small>Note.3</small>	±4.0%
	LINE REGULATION	±0.5%
	LOAD REGULATION	±0.5%
	SETUP, RISE TIME <small>Note.7</small>	1000ms, 80ms / 115VAC at full load 500ms, 80ms / 230VAC
HOLD UP TIME (Typ.)	16ms/230VAC 16ms/115VAC at full load	
INPUT	VOLTAGE RANGE <small>Note.5</small>	90 ~ 305VAC 127 ~ 431VDC
	FREQUENCY RANGE	47 ~ 63Hz
	POWER FACTOR (Typ.)	PF>0.97/115VAC, PF>0.95/230VAC, PF>0.92/277VAC at full load (Please refer to "Power Factor Characteristic" curve)
	EFFICIENCY (Typ.)	87%
	AC CURRENT (Typ.)	0.6A / 115VAC 0.3A / 230VAC 0.25A/277VAC
	INRUSH CURRENT (Typ.)	COLD START 50A(twidth=210µs measured at 50% Ipeak) at 230VAC
	LEAKAGE CURRENT	<0.75mA / 240VAC
PROTECTION	OVER CURRENT <small>Note.4</small>	95 ~ 108% Protection type : Constant current limiting, recovers automatically after fault condition is removed
	SHORT CIRCUIT	Hiccup mode, recovers automatically after fault condition is removed.
	OVER VOLTAGE	28 ~ 35V Protection type : Shut down and latch off o/p voltage, re-power on to recover
	OVER TEMPERATURE	Shut down o/p voltage, re-power on to recover
ENVIRONMENT	WORKING TEMP.	-40 ~ +70°C (Refer to "Derating Curve")
	WORKING HUMIDITY	20 ~ 95% RH non-condensing
	STORAGE TEMP., HUMIDITY	-40 ~ +80°C, 10 ~ 95% RH
	TEMP. COEFFICIENT	±0.03%/°C (0 ~ 50°C)
	VIBRATION	10 ~ 500Hz, 5G 12min./1cycle, period for 72min. each along X, Y, Z axes
SAFETY & EMC	SAFETY STANDARDS <small>Note.6</small>	UL8750, CSA C22.2 No. 250.0-08(except for 48V, 54V), IEC 60950-1, EN61347-1, EN61347-2-13 independent, EN62384, IP67, J61347-1, J61347-2-13 approved ; design refer to UL60950-1, TUV EN60950-1
	WITHSTAND VOLTAGE	I/P-O/P:3.75KVAC
	ISOLATION RESISTANCE	I/P-O/P:100M Ohms / 500VDC / 25°C/ 70% RH
	EMC EMISSION	Compliance to EN55015, EN61000-3-2 Class C (≥60% load) ; EN61000-3-3
	EMC IMMUNITY	Compliance to EN61000-4-2,3,4,5,6,8,11; EN61547, EN55024, light industry level(surge 2KV), criteria A
OTHERS	MTBF	438.8Khrs min. MIL-HDBK-217F (25°C)
	DIMENSION	162.5*43*32mm (L*W*H)
	PACKING	0.44Kg; 32pcs/15.08Kg/0.93CUFT
NOTE	<ol style="list-style-type: none"> 1. All parameters NOT specially mentioned are measured at 230VAC input, rated load and 25°C of ambient temperature. 2. Ripple & noise are measured at 20MHz of bandwidth by using a 12" twisted pair-wire terminated with a 0.1µf & 47µf parallel capacitor. 3. Tolerance : includes set up tolerance, line regulation and load regulation. 4. Please refer to "DRIVING METHODS OF LED MODULE". 5. Derating may be needed under low input voltages. Please check the static characteristics for more details. 6. Suitable for indoor use or outdoor use without direct sunlight exposure. Please avoid immerse in the water over 30 minutes. 7. Length of set up time is measured at cold first start. Turning ON/OFF the power supply may lead to increase of the set up time. 8. The power supply is considered as a component that will be operated in combination with final equipment. Since EMC performance will be affected by the complete installation, the final equipment manufacturers must re-quality EMC Directive on the complete installation again. 9. To fulfill requirements of the latest ErP regulation for lighting fixtures, this LED power supply can only be used behind a switch without permanently connected to the mains. 	

Mechanical Specification

Case No. LPF-60B Unit:mm

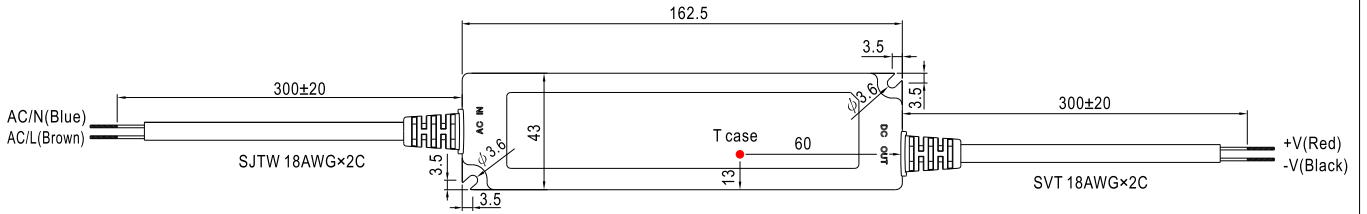

※ T case: Max. Case Temperature.



Recommend Mounting Direction

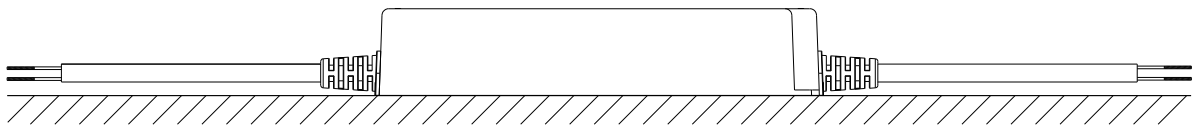

Block Diagram

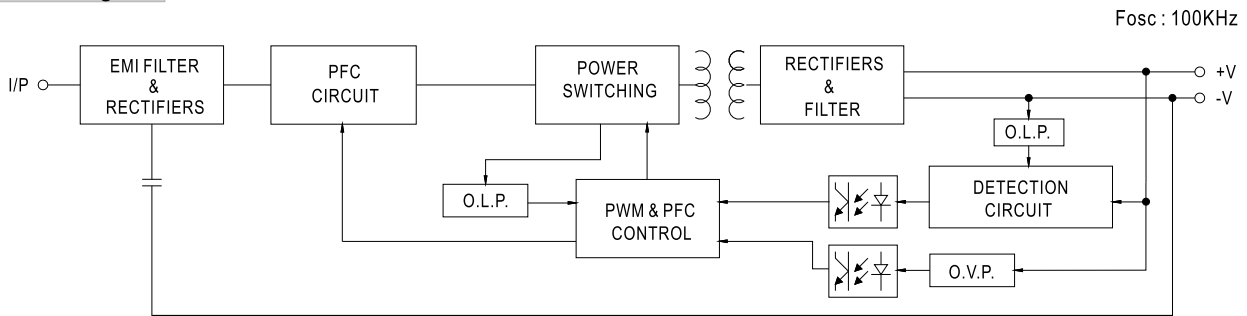

Derating Curve

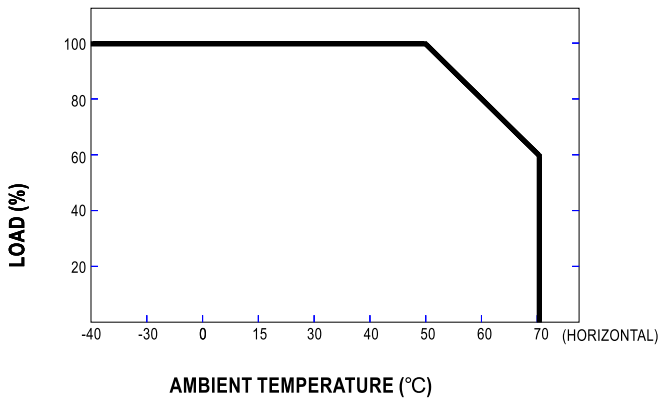

Static Characteristics

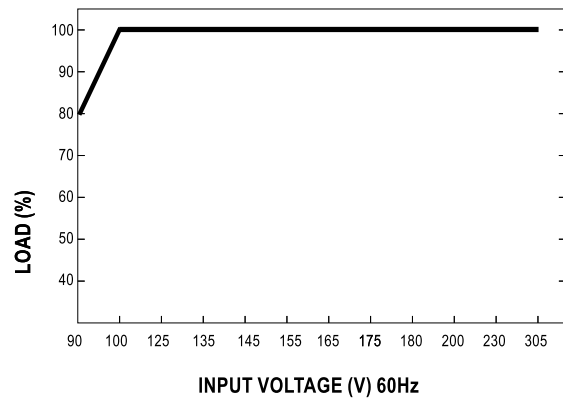

Power Factor Characteristic

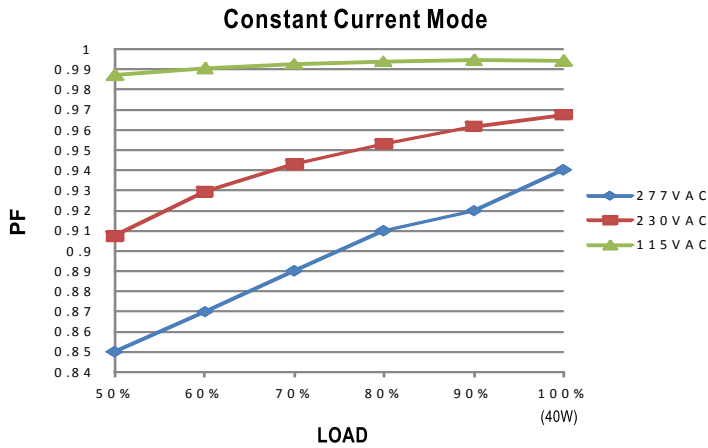

EFFICIENCY vs LOAD (48V Model)

LPF-40 series possess superior working efficiency that up to 90% can be reached in field applications.

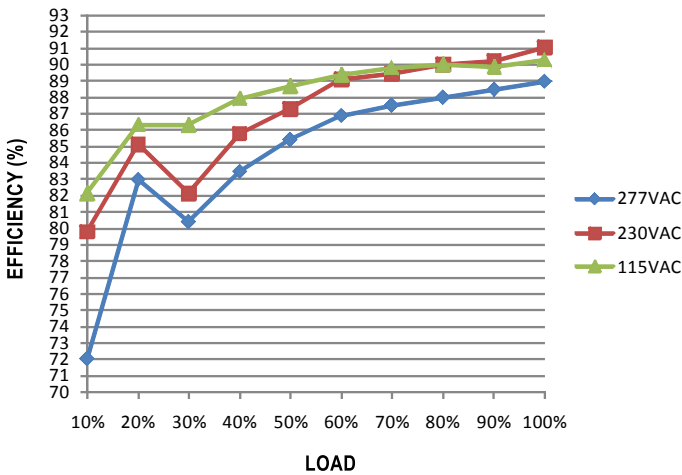

DRIVING METHODS OF LED MODULE

There are two major kinds of LED drive method "direct drive" and "with LED driver".

A typical LED power supply may either work in "constant voltage mode (CV) or constant current mode (CC)" to drive the LEDs.

Mean Well's LED power supply with CV+ CC characteristic can be operated at both CV mode (with LED driver, at area (A) and CC mode (direct drive, at area (B)).

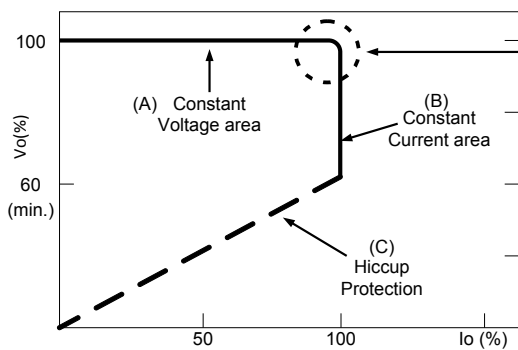

Typical LED power supply I-V curve

In the constant current region, the highest voltage at the output of the driver depends on the configuration of the end systems.

Should there be any compatibility issues, please contact MEAN WELL.