



Item#: **91691**
LED HIGH WATTAGE 360° LAMP
 REPLACEMENT LAMPS FOR OUTDOOR POLE/ARM
 MOUNTED DECORATIVE LUMINAIRES (TYPE B)

FEATURES

- Environmentally friendly; uses less energy than a traditional lamp.
- 360° optical design that provides even light distribution.
- High Voltage Surge Protection (6KV).
- Hollow heat sink for increased cooling air flow.
- High lumen output.
- Silicone gaskets.

APPLICATION

Replacement lamps for top post, high bays, parking lots and street lighting.

LIGHT DISTRIBUTION CURVE

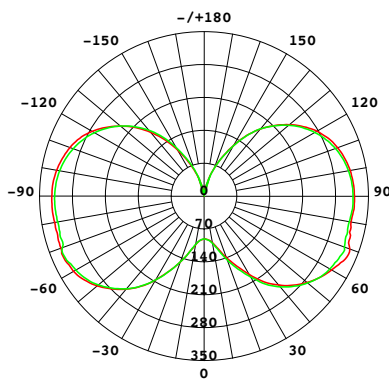

ELECTRICAL

Wattage	27W
Voltage	120-277V
Current	0.27A
Power Factor	0.9
Total Harmonic Distortion (THD)	--

LIGHTING PERFORMANCE

Lumens	3510
Lumens Per Watt (Lm/W)	130
Color Temperature (CCT)	3000K
Color Rendering (CRI)	80
R9 (Red Value)	N/A
R13 (Skin Tones)	N/A
Beam Angle	360°
Light Distribution	Type VS
Dimmable Lighting Control	

ENVIRONMENT

Operating Temperature	-40° ~ 122°F
Suitable Location	DAMP
Ingress Protection Rating	IP63
Fixture Type	Enclosed

LIFESPAN

Average Life (Hours)	50,000
Warranty (Years)	5

COMPONENTS

LED Light Source	JuFei 2835
------------------	------------

CONSTRUCTION

Housing	Aluminum / PC
Lens	Clear
Base / Power Supply	E26 - Medium

QUALIFICATIONS



Published lumens on LED products are approximate and may vary slightly.

PERFORMANCE DATA

PACKAGING

Item#: **91691**
LED HIGH WATTAGE 360° LAMP



DIMENSIONS (Inches)

Length (MOL)	7.3"
Width/Diameter (MOD)	3.8"
Weight (Lbs)	1.7

Line drawings may not be to scale and are for general reference only.

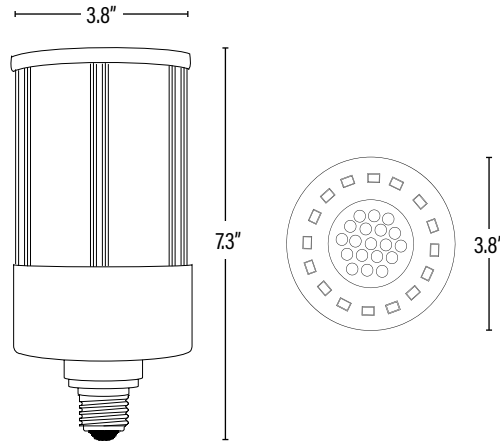

SUPPORTING DOCUMENTS (Grey = not available at this time.)

Product Sheet	VIEW
Install Instructions	VIEW
IES Download from Web Item	VIEW
Photometric	VIEW
LM79	VIEW
LM80	VIEW

PACKAGING

		UPC	DIMENSIONS (LxWxH)	GROSS WEIGHT (Lbs)
Master Carton	12	10811768028697	18" x 13.5" x 10"	25.4
Individual Box	1	811768028690	4.3" x 4.3" x 9.3"	1.9
Country of Origin	China			
HS Tariff	9405.40.8200			

ORDERING

ITEM#	DESCRIPTION	CASE
91691	LED 27WT30/360°/CL/30K/MED/120-277V/V5 - SUPERIOR LIFE®	12

ADDITIONAL INFORMATION:

Family Item: 91577/5000K

TOP VIEW



PERFORMANCE DATA

PACKAGING