



ROUND EDGE-LIT LED
Performance Data

CRI

82+ Standard, 90+ Optional

Tone-Select™ - CCT Selectable

3000K, 3500K, 4000K

Voltage

120-277V

Projected Lifetime

50,000 Hours (L70)

Dimming

0-10V Dimming Standard,
100% down to 1%

Operating Temperature

-4F° to 122°F (-20°C to +50°C)

Listing

Suitable for indoor, dry and damp locations.

Client: _____

Order #: _____

Project: _____

Type: _____ Qty: _____

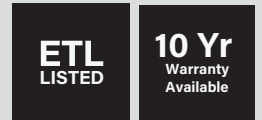

Description

The Circa 2™ luminaire seamlessly integrates design and performance, catering to the discerning architectural community with top-tier profiles and cutting-edge LED technology. Its acrylic matte diffusion cover enhances comfort and light quality, while edge lighting ensures consistent and uniform illumination.

Offering versatility, Circa 2™ comes in five sizes with varying lumen outputs and a choice of up, down, or combined lighting. Custom Lumen Output (CLO) capability further enhances its adaptability, making it suitable for spaces ranging from multi-purpose rooms to retail establishments, adapting effortlessly to diverse environments.

Features

- Heavy gauge extruded aluminum housing. Spun aluminum driver housing. Vacuum formed, single piece acrylic lens.
- Sizes: 14", 18", 24", 35" and 47" diameters
- Aircraft, Stem, Surface/Wall Mount
- Powder Coating finish is adopted, White Matte Texture, Black Matte Texture are standard, Silver Matte Texture customized.
- LED Light Engine is available as HLO (High Lumen Output) and SLO (Standard Lumen Output) providing efficient illumination, Support Direct, Indirect/Direct distribution.
- The Circa 2™ boasts a single sheet acrylic matte diffusion cover to make it stand out from the competition. There are no seams on this elegant disc.

Listed

Ordering Information

A FIXTURE SERIES

CRI Circa 2™

B SIZE

14	14"
18	18"
24	24"
35	35"
47	47"

C CCT

303540 3000K/3500K/4000K

D FINISH

W	Textured White
B	Textured Black

Custom colors available upon request

E MOUNTING OPTIONS

CR-AC-W-96	Aircraft Cable (96inx3) White Canopy
CR-AC-B-96	Aircraft Cable (96inx3) Black Canopy
CR1424-STMK-W	Stem Mount for 14", 18" & 24" White (39.5in)
CR1424-STMK-B	Stem Mount for 14", 18" & 24" Black (39.5in)
CR3547-STMK-W	Stem Mount for 35" & 47" White (39.5in)
CR3547-STMK-B	Stem Mount for 35" & 47" Black (39.5in)
CR14-SMK-W	Surface Mount for 14" & 18" White
CR14-SMK-B	Surface Mount for 14" & 18" Black
CR24-SMK-W	Surface Mount for 24" White
CR24-SMK-B	Surface Mount for 24" Black
CR3547-SMK-W	Surface Mount for 37 & 47" White
CR3547-SMK-B	Surface Mount for 37 & 47" Black

F WARRANTY¹

-	5 Year Warranty
10	10 Year Warranty
10L	10 Year Warranty including labor

¹5 Year Warranty is Standard unless specified

Dimensions

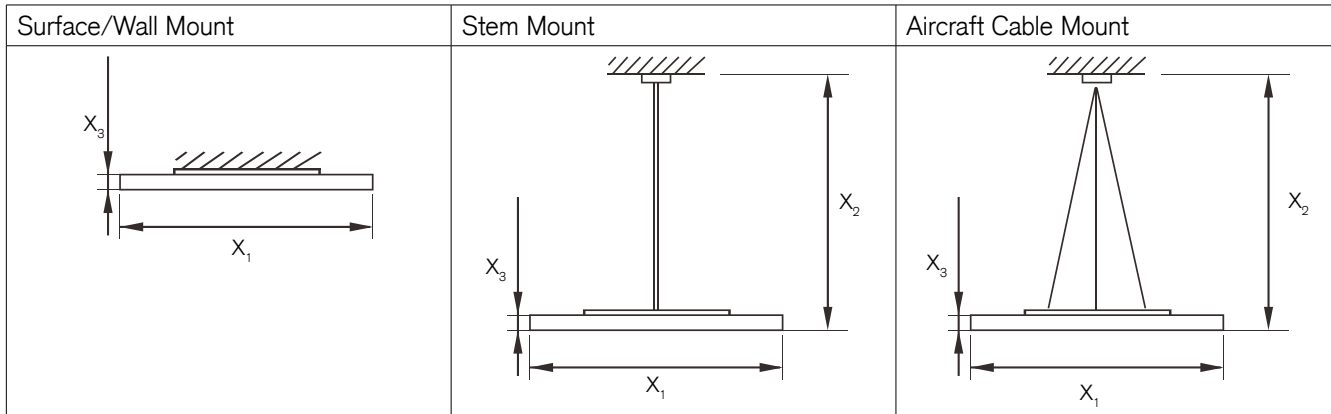

Inches

	Surface/Wall Mount	Stem Mount	Aircraft Cable Mount
X₁	14"/18"/24"/35"/47"	14"/18"/24"/35"/47"	14"/18"/24"/35"/47"
X₂	-	39.5"	96"
X₃	2.2"	2.2"	2.2"

Specification Chart

Size	Wattage	Lumens		Output Current		Replacement Driver	
		Up Light	Down Light				
14	14"	28	700LM	1800LM	700mA		XZ-SA30B-420070
18	18"	50	1500LM	3500LM	1200mA		XZ-SA50B-420125
24	24"	62	2000LM	4500LM	1500mA		XZ-SA60B-420150
35	35"	123	4200LM	10000LM	D1: 1400mA	D2: 1400mA	XZ-SA60B-420150 (2 ea.)
47	47"	132	4700LM	11000LM	D1: 1500mA	D2: 1500mA	XZ-SA60B-420150 (2 ea.)

Photometric

Polar Graph - 14" 30/35/40K 28W

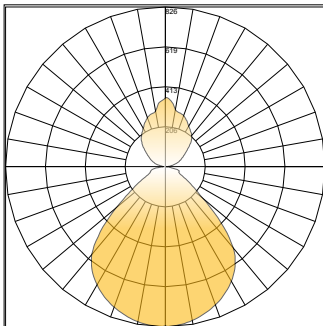

Polar Graph - 18" 30/35/40K 40W

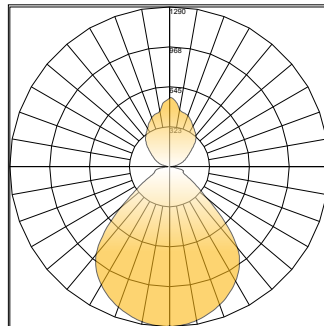

Polar Graph - 24" 30/35/40K 68W

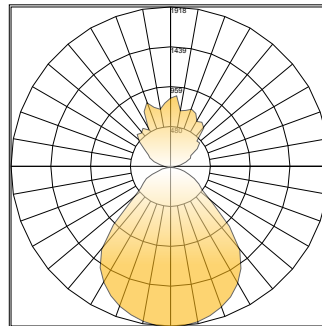

Polar Graph - 36" 30/35/40K 123W

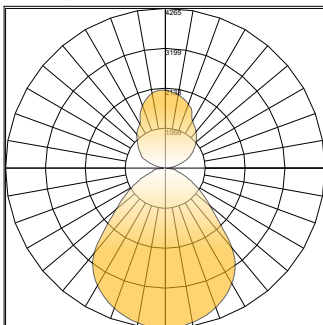

Polar Graph - 47" 30/35/40K 132W

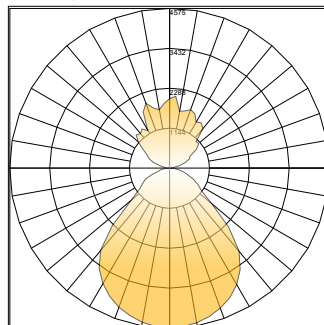

Unified Glare Rating (UGR)

LED Flat Panel with micro-prismatic technology:

- Light is redirected from 60° to 90° degrees of luminaire, UGR <19
- Conical structures built into the lens minimize high angle glare
- Allows for increased efficacy, rather than lumen output glaring at occupants
- High efficiency and energy saving
- Protection class: IP20 Damp Location Rated
- Increased productivity



□ = Volumetric flat panel with micro-prismatic lens will reduce glare going into the occupant's eyes — = 90° = 60°

Standard LED Flat Panel:

- Harsh glare at viewing angles above 60°, UGR >24
- Wide beam angle at 120°
- Uncomfortable glare
- Reduction in visibility caused by intense light source in field of view
- Protection class: IP22 protects only from objects greater than 12 millimeters
- Loss of productivity



■ = High glare flat panel makes occupant's eyes feel uncomfortable — = 90° = 60°

Optics Detail

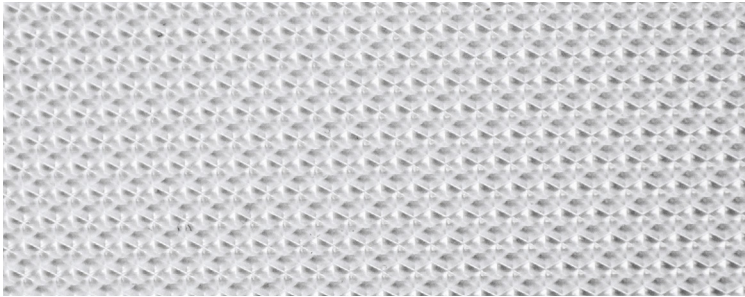

Micro-prismatic technology redirects high-angle light, reducing visual glare. The light above 60° is suppressed to improve the Unified Glare Rating (UGR). This allows for the luminaire to meet recommended standards for office and indoor lighting.

UGR Criteria

UGR:	Hopkinson's Criterion:
<10	Imperceptible
<13	Just Perceptible
<16	Perceptible
<19	Acceptable
>22	Unacceptable
>25	Just Uncomfortable
>28	Uncomfortable

Micro-prismatic conical structures provide the most optimal luminance of a fixture from any viewing angle. The UGR rating of less than 19 provides the most acceptable glare for task lighting.