

6" ARCHITECTURAL CYLINDER

OVERVIEW

Lumens

Delivers up to 110 lumens per watt

CRI

90 (Standard), 80 (Optional)

CCT Selectable

2700K, 3000K, 3500K, 4000K, 5000K

Voltage

120-277V

Dimming

0-10V & Triac, Dali or MESH

Operating Temperature

-13°F ~ 104°F

Suitable Location

Damp

Standard Finishes

Black

White

 Custom colors available.



The Architectural Cylinder combines a sleek, modern profile with high-performance illumination. Its clean design complements contemporary spaces, while versatile mounting, beam, and lumen options adapt to a wide range of applications. Built with durable construction and efficient LED technology, it delivers reliable, long-lasting light and is ideal for both ambient and focal lighting needs.

Features

- Elevate your space with sleek, modern lighting designed for contemporary interiors and commercial environments.
- Offered in a three standard lengths with optional custom sizing.
- Selectable wattage and CCT lets you customize your lighting with three adjustable power levels and five color temperatures.
- Multiple beam angles support both focused accent and broad ambient lighting.
- Available in pendant, surface, or wall mounting to suit any layout.
- Ideal for offices, retail, hospitality, galleries, lobbies, and conference rooms, delivering style and functionality in every detail.



Pending ETL

10 YR

Warranty
Available⁵

BUILD WORKSHEET

Contact sales representative to order.



CYLINDER MODEL

CY6	5C		U		CRI		DIMMING		FINISH		B	MOUNTING		
SERIES*	LENGTH	OUTPUT	CCT	VOLTAGE	OPTICS	CRI	DIMMING	FINISH	TRIM	MOUNTING				
CY6 6" Architectural Cylinder	A 5.9", Standard	P20 Selectable: 10W, 15W, 20W	5C Selectable: 2700K, 3000K, 3500K, 4000K, 5000K	U 120-277V	25 25°	8¹ 80	X 0-10V/Triac	K Black	B Baffle	PC Pendant Cord Mount				
	B 13.2", Standard	P40 Selectable: 20W, 30W, 40W			36 36°						9 90, Standard	D Dali	W White	PS Pendant Stem Mount
	C 13.8", Standard	P55 Selectable: 45W, 50W, 55W			60 60°						M Mesh Control	C Custom Color	SM Surface Mount	
	X Custom Length										W Dim to Warm			

CYLINDER MODEL (cont'd)

CONTROLS	EMERGENCY	WARRANTY
BT² Bluetooth Mesh Control	8EM 8W Emergency Backup	10 10-Year Optional
Blank None	3EM³ 3.5W Emergency Power Kit	Blank 5-Year Standard
	Blank None	





ACCESSORY (Ordered separately)

LAMP SHADE	
	
CY6-LS-K Black Finish	CY6-LS-W White Finish

Baffle Trim



MOUNTING OPTIONS (Each option ordered separately)

CANOPY TYPE ³			
			
CY-CS-[K,W] 5" Standard Canopy for Recessed J-Box	CY-CL-[K,W] 5" Slim Canopy for Recessed J-Box	CY-CC-[K,W] 5" Canopy for Surface J-Box with Conduit Cover Cable	CY-CP-[K,W] 5" Canopy for Recessed J-Box + Safety Cable
Compatible with cord mounting for length A and B only. Compatible with stem or surface mounting in all lengths.	Compatible with cord mounting for length A and B only. Compatible with stem mounting in all lengths.	Compatible with cord mounting for length A and B only. Compatible with stem or surface mounting in all lengths.	Compatible with cord mounting for length C. Includes a 10FT safety cable.

CORD LENGTH

For Cord Mounting
CY-3AC-[K,W] 3FT, 5-Core 300V Cord
CY-4AC-[K,W] 4FT, 5-Core 300V Cord
CY-6AC-[K,W] 6FT, 5-Core 300V Cord
CY-8AC-[K,W] 8FT, 5-Core 300V Cord

STEM LENGTH	WHIP LENGTH
	CY-WP-XX Custom Whip Length for Stem Mount
Linkable	Blank 2FT Whip, Standard
CY-ST-[K,W] 5/8" Threaded Stem Pipe - 1FT Length	
Up to 8 sections can be connected together.	

10 YR
Warranty Available⁵

* Consult with sales representative for MOQ and lead time.
¹ Only available in Length: C, Output: P55.
² Compatible with Standard Canopy (CY-CS) only.
³ Compatible with Surface Mount (SM) and Standard Canopy (CY-CS) only.
⁴ See page 4 for mounting details.
⁵ 5 Year Warranty is Standard unless specified.

PERFORMANCE DATA

Lumen outputs shown are for 4000K

LENGTH	WATTAGE	LUMENS	LPW	CRI
A	10W	900	90	90 (Standard)
	15W	1,350		
	20W	1,800		
B	20W	1,800	90	90 (Standard)
	30W	2,700		
	40W	3,600		
C	45W	4,050	90	90 (Standard)
	50W	4,500		
	55W	4,950		
C	45W	4,950	110	80 (Optional)
	50W	5,500		
	55W	6,050		

PHOTOMETRICS

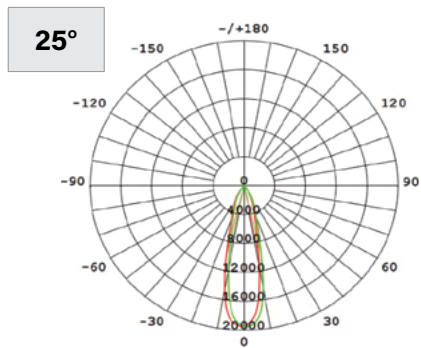

AVERAGE BEAM ANGLE (50%): 24.8 DEG

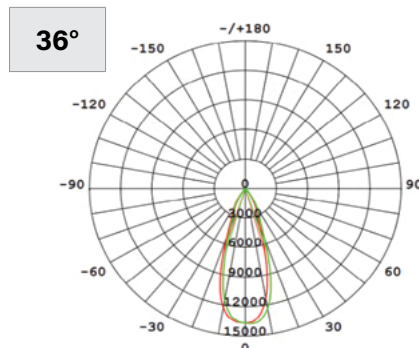

AVERAGE BEAM ANGLE (50%): 14.5 DEG

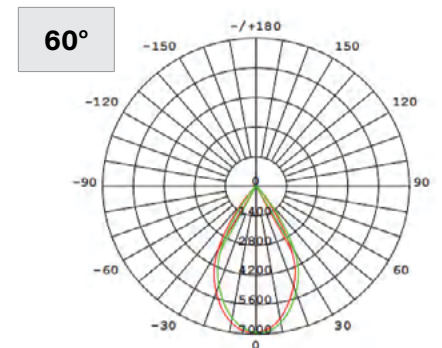

AVERAGE BEAM ANGLE (50%): 58.2 DEG

DIMENSIONS

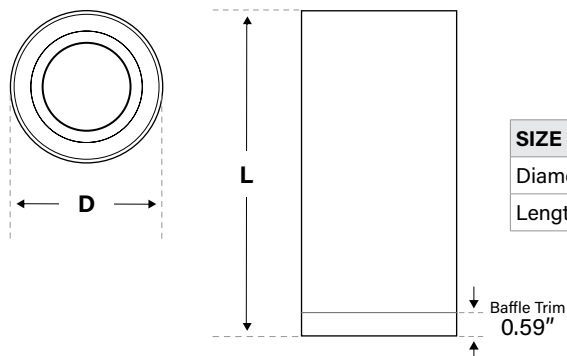

SIZE	A	B	C
Diameter (D)	5.55"		
Length (L)	6.48"	13.78"	14.38"

LAMP SHADE (Optional)

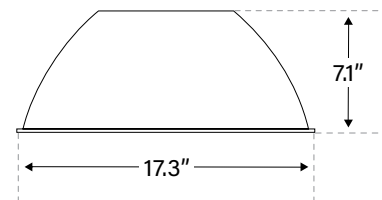

MOUNTING OPTIONS

Standard Canopy (CS)

Designed for recessed J-Box; compatible with cord mounting for length A and B only. Compatible with stem or surface mounting in all lengths.

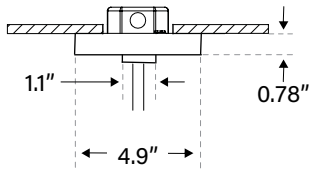

Slim Canopy (CL)

Designed for recessed J-Box; compatible with cord mounting for length A and B only. Compatible with stem mounting in all lengths.

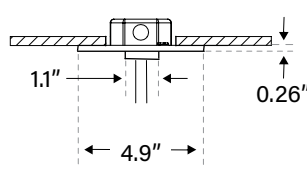

Surface Canopy (CC)

Fits surface J-Box with conduit cover; compatible with cord mounting for length A and B only. Compatible with stem or surface mounting in all lengths.

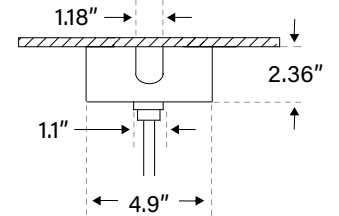

Pendant Canopy (CP)

Designed for recessed J-Box; compatible with cord mounting for length C.

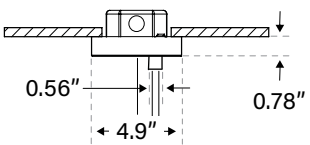

*Does not include cord.
Includes a 10FT safety cable.*

Wall Mount (WM)

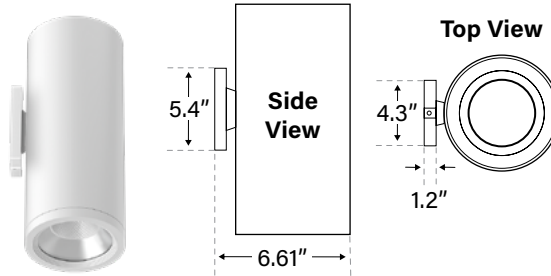

Linkable Stem

Available in 1-ft sections. Up to 8 sections can be linked together.

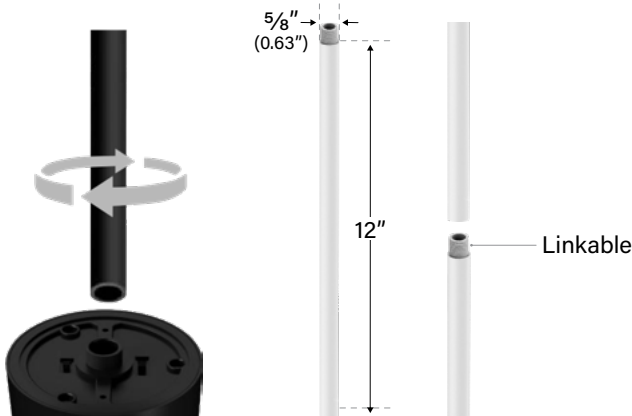

BLUETOOTH CONTROL

Compatible only with Standard Canopy (CY-CS).

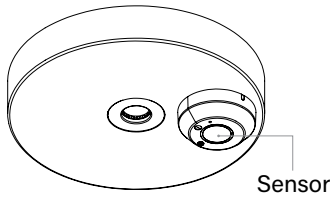

Features

- Specifically designed for use with the standard canopy and mounts via a pre-drilled hole in the canopy.
- Built-In Magnetic Base: Allows quick, secure attachment directly to the canopy for easy installation.
- Low-Voltage Operation: Safe and energy-efficient, operating on a low-voltage system for enhanced safety.
- No Sensor Required: Supports seamless app-based dimming for simple, smart control.

SPECIFICATIONS	
Input Voltage	DC 12V
Detection Range	32ft max.
Mounting Height	15ft max.
Operating Temperature	-22° ~ 149°F
IP Rating	IP20

8W EMERGENCY BACK-UP

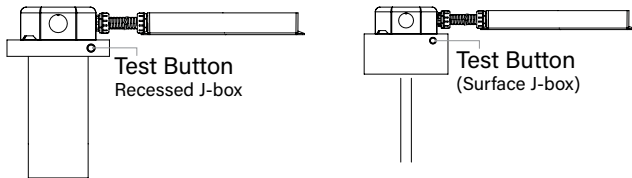

Features

- Lithium-ion battery with a built-in AC relay.
- Rest mode.
- Automatic startup self-test (LED indication).
- Tests lamp compatibility and dimming performance.
- Over-current, over/under-voltage, and short-circuit protection.

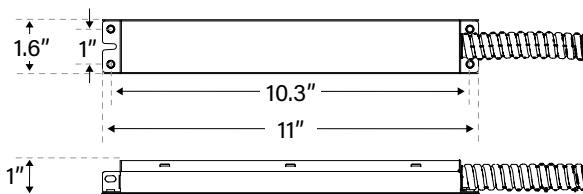

SPECIFICATIONS	
Input Voltage	100-277V, 50/60Hz, 4.5W max.
Input Current	80mA max.
Power Factor	>0.5
L-in to L-out (Normal Driver Input)	AC 3A max.
Output Voltage (EM Mode)	DC 150-170V
Output Power (EM Mode)	8W
Battery Pack Voltage/Capacity	Li-ion, 7.2V2.6Ah, 18.72Wh
Startup Capability/Time	15W, 500ms
Recharge Time	≥ 24 Hours
Discharge Time	90 Minutes
Ambient Operating Temperature	32° ~ 122°F
Suitable Location	Damp
IP Rating	IP20
Suitable Lamp Power	6-80W
Lamp power that must be with 0-10V or 1-10V dimmer function.	≥8W
Lamp power at 1V dimmer voltage (1W margin power).	≤7W

3.5W EMERGENCY POWER KIT

Compatible with Surface Mount (SM) and Standard Canopy (CY-CS) only.

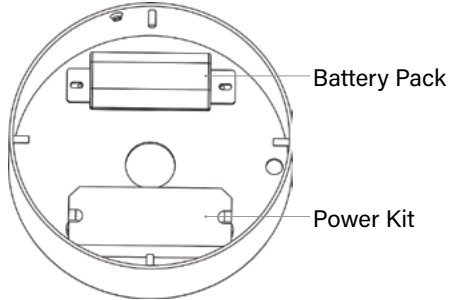

Features

- Converts standard LED fittings into emergency-ready units.
- Works with LiFePO₄ batteries and external driver LED fittings.
- 1500 mAh for long-lasting emergency lighting.
- Built-in backup power for outages.
- Test switch and charge indicator for easy maintenance.

SPECIFICATIONS	
Input Voltage	100-277V, 50/60Hz
Input Power	3W
Input Current	50mA
Power Factor	>0.5
L-in to L-out (Normal Driver Input)	AC 3A max.
Output Voltage	DC 20-50V
Output Power	3.5W
Output Current	75mA CC
Battery Pack Voltage/Capacity	LiFePO ₄ 6.4V 1500mAh, 9.60Wh
Recharge Current	200mA max.
Recharge Time	24 Hours
Discharge Time	90 Minutes
Ambient Operating Temperature	32° ~ 122°F
AC LED Driver Output (+/-)	DC 50V, 1A max.
Suitable Location	Damp
IP Rating	IP20
Lumen Factor	140 LM/W
Max. Case Temperature <i>t_c</i>	158°F (70°C)