

# JUGGERNAUT

## Modern Full Cutoff LED Wall Pack

Client: \_\_\_\_\_ Order #: \_\_\_\_\_  
 Project Name: \_\_\_\_\_ Type: \_\_\_\_\_ Qty: \_\_\_\_\_

### Performance Data

**CRI**  
70+

**CCT**  
3000K, 4000K, 5000K

**Average Lifetime**  
50,000 Hours

**Voltage**  
120-277V

**Dimming**  
0-10V dimming standard,  
100% down to 10%

**Operating Temperature**  
-40° ~ 104°F (-40° ~ 40°C)

**Listing**  
IP65 - Suitable for dry,  
damp, wet locations.



**10 Yr**  
Warranty  
Available

### Description

The Juggernaut full cutoff LED wall pack features a slim, yet striking aesthetic and is designed as the premier full cutoff wall-mount lighting solution. This modern luminaire is ideal for a variety of outdoor applications, including educational facilities, office space exteriors, municipal buildings, and as security lighting. The Juggernaut has been constructed to provide maximum energy cost savings over traditional light fixtures in mind, with an optional integrated motion sensor delivering even deeper savings.

### Features

- Low-profile, sleek design provides a more modern aesthetic compared to traditional wall packs
- Full cutoff light output reduces light pollution, delivering illumination only where it is needed most
- Three housing sizes provide flexibility depending on the desired aesthetic
- Available in 3000K (warm white), 4000K (neutral white) or 5000K (cool white) color temperatures
- Optional FSP-211 motion sensor integrates directly into fixture housing
- Performs at up to 115 lumens per watt
- Type III short IES distribution

### Ordering Options **Contact sales representative to order.**

#### FIXTURE SERIES

D464-L Modern Full Cutoff LED Wall Pack

#### WATTAGE/LUMENS

24 24W/2660<sup>2</sup>

42 42W/4250<sup>2</sup>

60 60W/6580<sup>2,3,8</sup>

80 80W/9210<sup>2,3,8</sup>

#### CCT

30 3000K<sup>7</sup>

40 4000K

50 5000K

#### VOLTAGE

U 120-277V

#### FINISH

Z Bronze<sup>1</sup>

W White

#### OPTIONS

T Photocell

7R NEMA 7-Pin Receptacle & Photocell<sup>5,6</sup>

E Emergency Backup<sup>5</sup>

M Motion Sensor w/Dimming (FSP-211)<sup>4,5,6</sup>

#### WARRANTY

- 5 Year Warranty

10 10 Year Warranty

10L 10 Year Warranty including labor

<sup>1</sup> Standard for fixture

<sup>2</sup> Delivered Lumens (4000K) - For 5000K multiply by 1.02

<sup>3</sup> 7 pin Twist Lock only offered in 60W & 80W

<sup>4</sup> 20ft mounting height lens standard. Contact factory for higher mounting.

<sup>5</sup> Not available for 24W

<sup>6</sup> M option not available in conjunction with 7R

<sup>7</sup> Contact factory for lead times

<sup>8</sup> Housing comes with threaded knockouts

### Dimensions

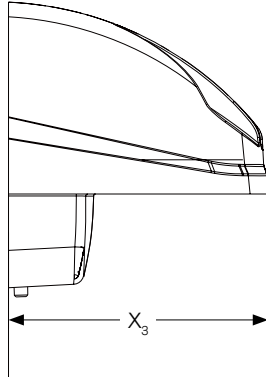
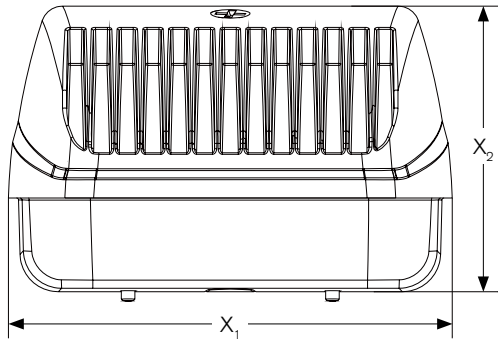

	Inches		
	24W	42W	60-80W
<b>X<sub>1</sub></b>	8.25	10.12	12.60
<b>X<sub>2</sub></b>	5.25	5.50	7.50
<b>X<sub>3</sub></b>	4.75	6.30	10.00

### Photometrics

Model 80W 4000K

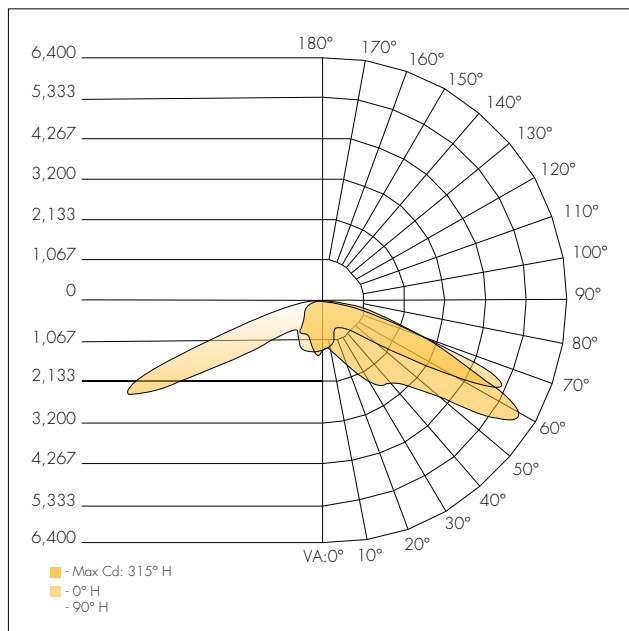

### Isofootcandle

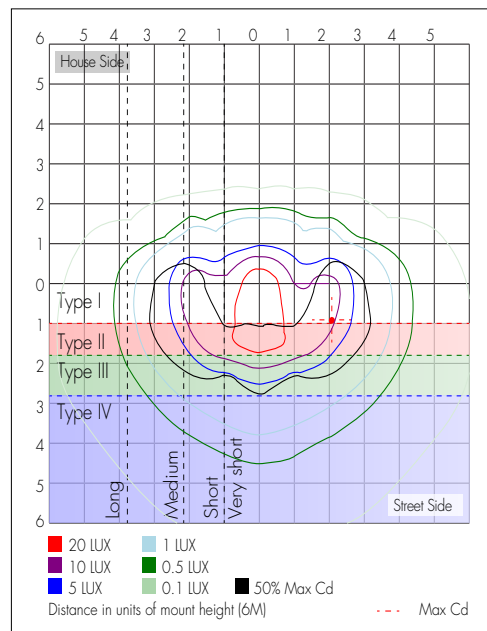

### Zonal Lumen Summary

Zone	Lumens	% Luminaire
0-30	1,001.3	10.9%
0-40	1,763.2	19.1%
0-60	4,697.5	51%
60-90	4,497.2	48.8%
70-100	1,599.0	17.4%
90-120	11.5	0.1%
0-90	9,194.7	99.8%
90-180	17.9	0.2%
0-180	9,212.6	100%

### Other Views

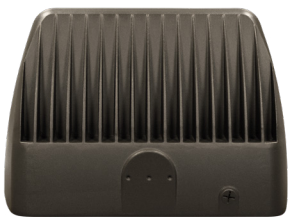

Top View



Front View



Side View

### Emergency Battery Operation

The emergency battery backup (EM option) is integral to the luminaire - no external housing required! This design provides reliable emergency operation while maintaining the aesthetics of the product.

The emergency battery will power the luminaire for a minimum duration of 90 minutes (maximum duration of three hours) from the time supply power is lost, per International Building Code Section 1006 and NFPA 101 Life Safety Code Section 7.9, provided luminaires are mounted at an appropriate height and illuminate an open space with no major obstructions.

The examples below show illuminance of 1 fc average and 0.1 fc minimum of the single-engine Type IV product in emergency mode.

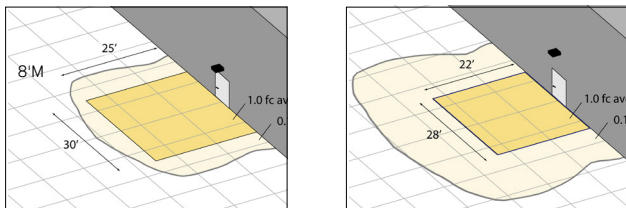

### Step Dimming & Bi-Level

#### FSP-211

The FSP-211 mounts in an outdoor lighting fixture and provides multi-level control based on motion. The sensor also includes a photocell to measure the ambient light level. It controls 0-10 VDC LED drivers or dimming ballasts, as well as non-dimming ballasts and, with an SFP-LX Lens, is rated for wet and cold locations. All control parameters are adjustable via a wireless configuration tool capable of storing and transmitting sensor profiles.

#### Key Factors

- Fully adjustable high and low dimmed light levels.
- Designed for LED fixtures; rated for extreme temperatures and up to 200,000 on/off cycles
- Hold off setpoint with automatic calibration option for convenience and added energy savings
- Adjustable via handheld wireless configuration tool
- IP66 rated with choice of lenses for wet and outdoor locations, and mounting heights from 8' to 40'
- Adjustable time delay and cut off delay



### Coverage & Dimensions

The FS-Lx lenses work with FSP-211 motion sensors to provide multi-level lighting control based on motion and the ambient light level. Four lens choices provide flexibility for varying mounting heights.

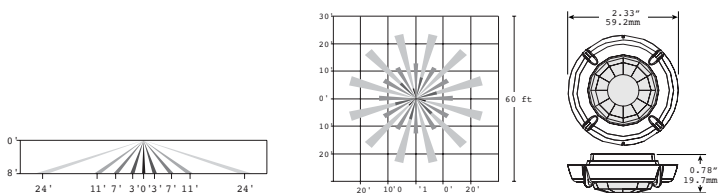

#### FSP-L2

360° lens, maximum coverage 48' diameter from 8' height

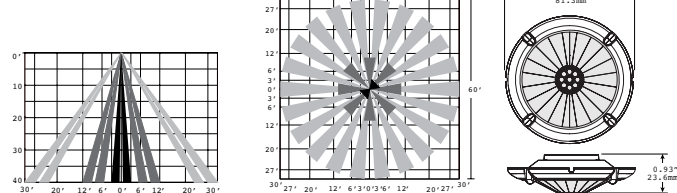

#### FSP-L4

360° lens, maximum coverage 60' diameter from 40' height

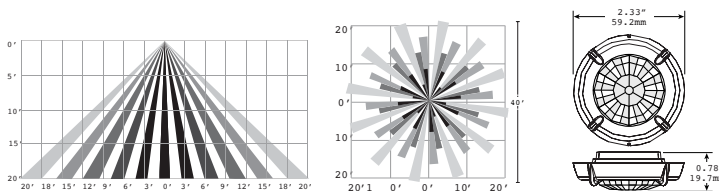

#### FSP-L3

360° lens, maximum coverage 40' diameter from 20' height

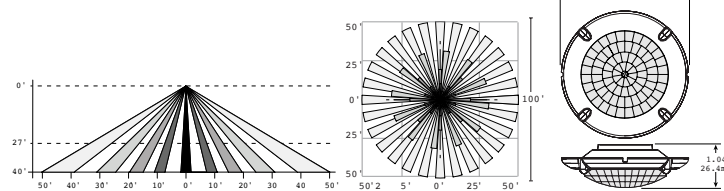

#### FSP-L7

360° lens, maximum coverage 100' diameter from 40' height