

COMPASS HIGH BAY - HC01

INSTALLATION INSTRUCTIONS

PLEASE FIND A QUALIFIED ELECTRICIAN FOR INSTALLATION. Read the instructions before installing or use of the luminaire.

WARNING, CAUTIONS AND OPERATING INSTRUCTIONS

- To reduce the risk of death, personal injury or property damage from fire, electric shock, falling parts, cuts/abrasions, and other hazards read all warnings and instructions included with and on the fixture box and all fixture labels.
- Before installing, servicing, or performing routine maintenance upon this equipment, follow these general precautions.
- Commercial installation, service and maintenance of luminaires should be performed by a qualified licensed electrician.
- For the installation: If you are unsure about the installation or maintenance of the luminaires, consult a qualified licensed electrician and check your local electrical code.
- To prevent wiring damage or abrasion, do not expose wiring to edges of sheet metal or other sharp objects.
- Do not make or alter any open holes in an enclosure of wiring or electrical components during kit installation.

WARNING: RISK OF FIRE OR ELECTRICAL SHOCK

- Turn off electrical power at fuse or circuit breaker box before wiring fixture to the power supply.
- Turn off the power when you perform any maintenance.
- Verify that supply voltage is correct by comparing it with the luminaire label information.
- Make all electrical and grounded connections in accordance with the National Electrical Code and any applicable local code requirements.
- All wiring connections should be capped with UL approved wire connectors.

CAUTION: RISK OF INJURY

- Risk of burn. Disconnect power and allow fixture to cool before handling fixture.
- Avoid direct eye exposure to the light source while it is on.
- Account for small parts and destroy packing material, as these may be hazardous to children.
- Green ground screw is provided in the proper location. DO NOT RELOCATE.
- Minimum 90° supply conductors.
- Suitable for Wet locations.

GENERAL WIRING DIAGRAM



WARNING DISCONNECT POWER BEFORE INSTALLING OR SERVICING.

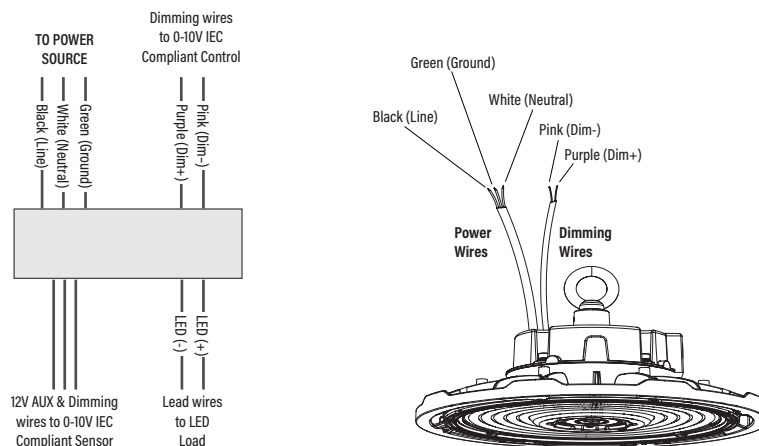

- Use Dim+, Dim- (DC 10V) marked leads to connect external dimmer circuit. If not connecting to an external 0-10V dimmer circuit, make sure fixture's 0-10V pink and purple leads are capped off separately. Failure to do so may cause fixture to perform incorrectly, and void warranty.
- The Power Wires and Dimming Wires with shrinkable tubing should not be damaged. (Damage may result in faulty connection).
- Class 1 Wiring Only.

COMPASS HIGH BAY - HC01

INSTALLATION INSTRUCTIONS

INSTALLATION

! WARNING DISCONNECT POWER BEFORE INSTALLING OR SERVICING.

HOOK/CHAIN MOUNT

- Install eye-bolt into the fixture and tighten it. (Fig. 1)
- Hang the fixture from the ceiling hook (Fig. 2) or chain (Fig. 3), provided by installer.
- Connect the electrical cables (see general wiring diagram), according to the local wiring rules.

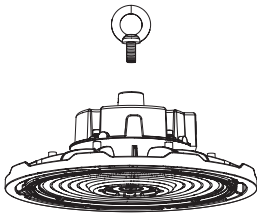

FIG. 1

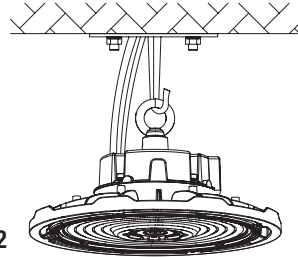

FIG. 2

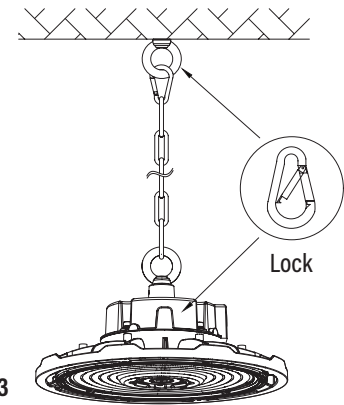

FIG. 3

PENDANT MOUNT (Adapter, sold separately)

- Remove the eye-bolt from the driver. (Fig. 4)
- Install the adapter (sold separately) and secure it to the driver using a screw (included with the adapter). (Fig. 5)
- Screw the adapter with the fixture onto a pole and secure it with a screw (included with the adapter). (Fig. 6)
- Connect the electrical cables (see general wiring diagram), according to the local wiring rules.

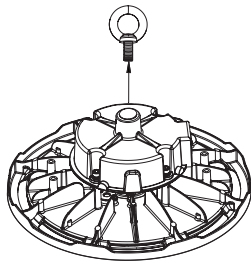

FIG. 4

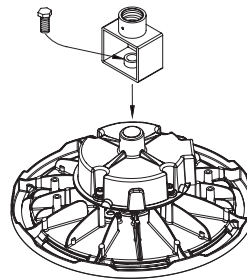

FIG. 5

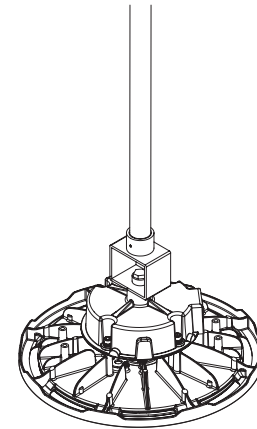

FIG. 6

CEILING/WALL MOUNT (Bracket, sold separately)

- Using the U-bracket as a template, mark and drill holes in the ceiling (Fig. 7).
- Install the anchors into the drilled holes. (Fig. 8)
- Attach the U-bracket to mounting surface utilizing appropriate hardware based upon the material of the ceiling. (Fig. 9)

Cont'd on next page.

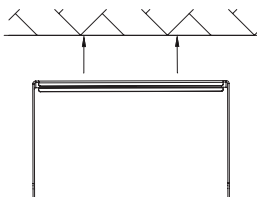
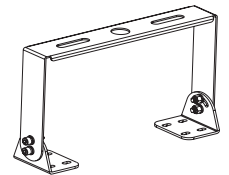

FIG. 7

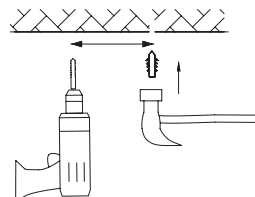

FIG. 8

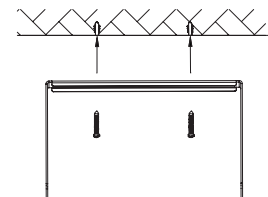

FIG. 9

COMPASS HIGH BAY - HC01

INSTALLATION INSTRUCTIONS

INSTALLATION *(cont'd)*

! WARNING DISCONNECT POWER BEFORE INSTALLING OR SERVICING.

CEILING/WALL MOUNT *(Bracket, sold separately)*

- Attach mounting feet to the fixture. (Fig. 10)
- Secure the fixture to the ceiling by connecting the U-Bracket to the mounting feet. (Fig. 11)
- Connect the electrical cables (see general wiring diagram), according to the local wiring rules.

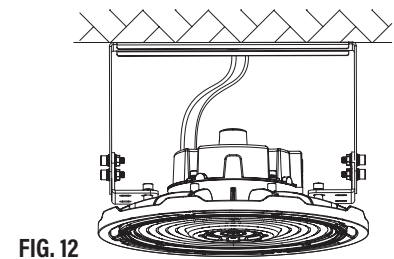
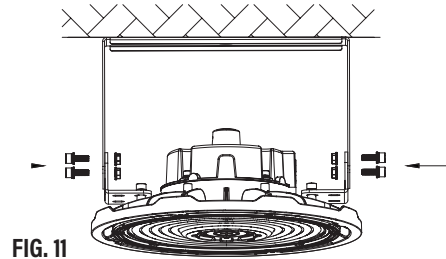
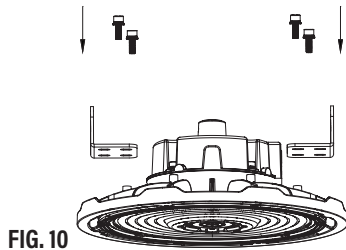

BRACKET APPLICATIONS

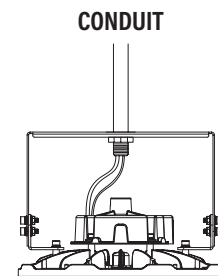
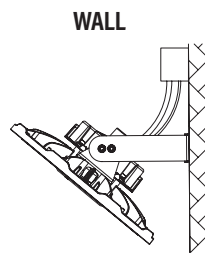
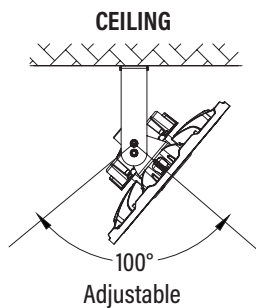

ACCESSORIES

! WARNING DISCONNECT POWER BEFORE INSTALLING OR SERVICING.

ISO - INTEGRATED SENSOR OPTION

(Sold separately)

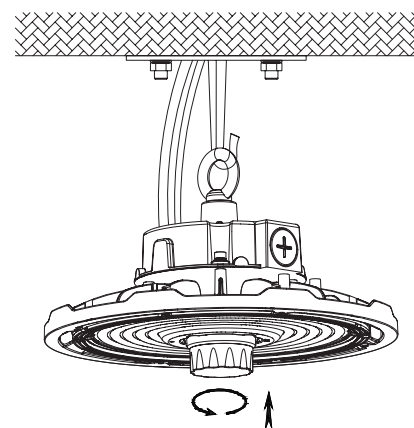
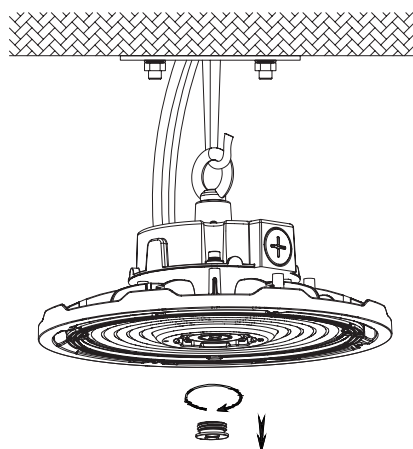

COMPASS HIGH BAY - HC01

INSTALLATION INSTRUCTIONS

ACCESSORIES



WARNING DISCONNECT POWER BEFORE INSTALLING OR SERVICING.

EMERGENCY BATTERY

(Sold separately)

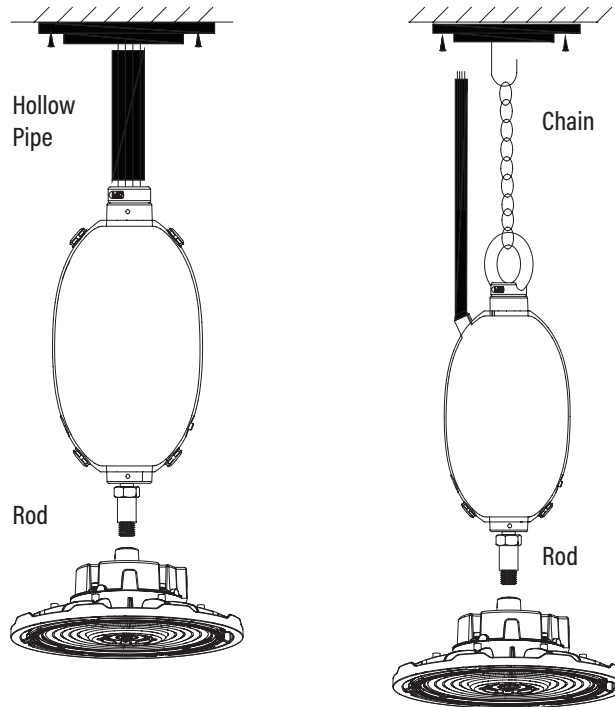

GENERAL EMERGENCY BATTERY WIRING DIAGRAM

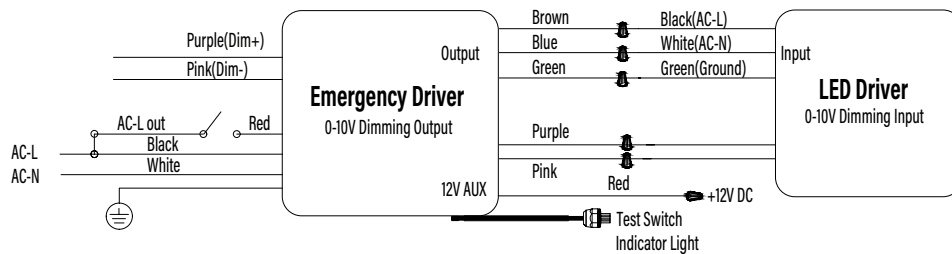

REFLECTORS

(Sold separately)

ACRYLIC

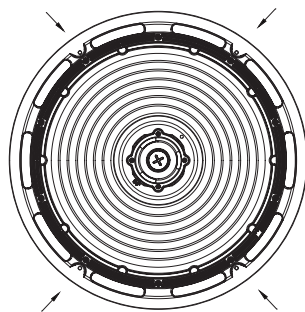
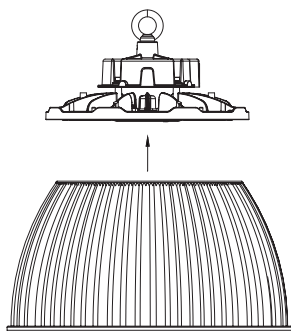

ATTACHMENT POINTS

ALUMINUM

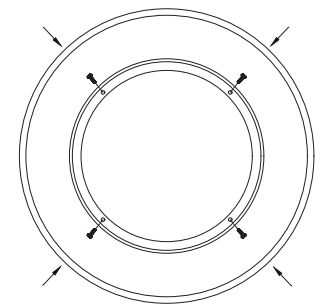
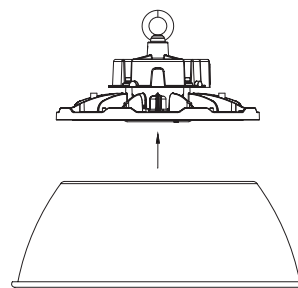

ATTACHMENT POINTS